

# marantz®

## Model SA-7S1 User Guide

---

Super Audio CD Player

CLASS 1 LASER PRODUCT  
LUOKAN 1 LASERLAITE  
KLASS 1 LASERAPPARAT



*SUPER AUDIO CD*

COMPACT  
**disc**  
DIGITAL AUDIO

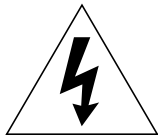
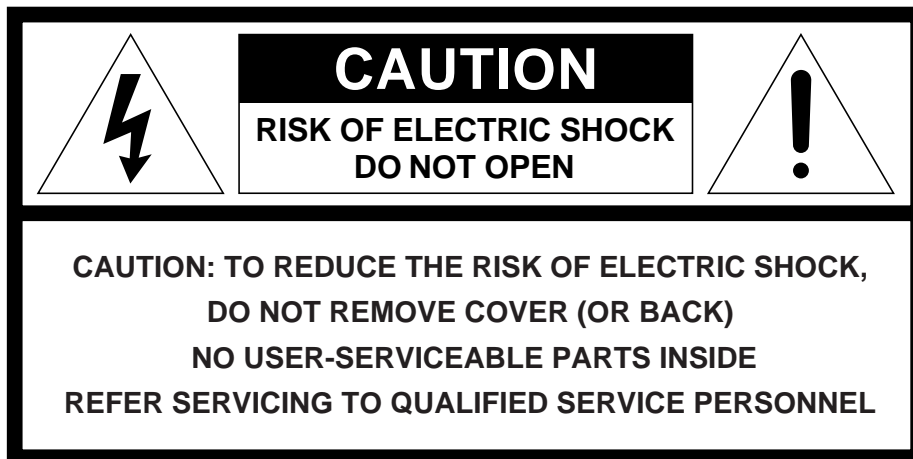

The lightning flash with arrowhead symbol within an equilateral triangle is intended to alert the user to the presence of uninsulated “dangerous voltage” within the product’s enclosure that may be of sufficient magnitude to constitute a risk of electric shock to persons.



The exclamation point within an equilateral triangle is intended to alert the user to the presence of important operating and maintenance (servicing) instructions in the literature accompanying the product.

## WARNING

**TO REDUCE THE RISK OF FIRE OR ELECTRIC SHOCK, DO NOT EXPOSE THIS APPLIANCE TO RAIN OR MOISTURE.**

---

**CAUTION: TO PREVENT ELECTRIC SHOCK, MATCH WIDE BLADE OF PLUG TO WIDE SLOT, FULLY INSERT.**

**ATTENTION: POUR EVITER LES CHOCS ELECTRIQUES, INTRODUIRE LA LAME LA PLUS LARGE DE LA FICHE DANS LA BORNE CORRESPONDANTE DE LA PRISE ET POUSSER JUSQU’AU FOND.**

---

## LASER SAFETY

This unit employs a laser. Only a qualified service person should remove the cover or attempt to service this device, due to possible eye injury.

**CAUTION : USE OF CONTROLS OR ADJUSTMENTS OR PERFORMANCE OF PROCEDURE OTHER THAN THOSE SPECIFIED HEREIN MAY RESULT IN HAZARDOUS RADIATION EXPOSURE.**

# IMPORTANT SAFETY INSTRUCTIONS

## READ BEFORE OPERATING EQUIPMENT

This product was designed and manufactured to meet strict quality and safety standards. There are, however, some installation and operation precautions which you should be particularly aware of.

1. Read these instructions.
2. Keep these instructions.
3. Heed all warnings.
4. Follow all instructions.
5. Do not use this apparatus near water.
6. Clean only with dry cloth.
7. Do not block any ventilation openings. Install in accordance with the manufacture's instructions.
8. Do not install near any heat sources such as radiators, heat registers, stoves, or other apparatus (including amplifiers) that produce heat.
9. Do not defeat the safety purpose of the polarized or grounding-type plug. A polarized plug has two blades with one wider than the other. A grounding type plug has two blades and a third grounding prong. The wide blade or the third prong are provided for your safety. If the provided plug does not fit into your outlet, consult an electrician for replacement of the obsolete outlet.
10. Protect the power cord from being walked on or pinched particularly at plugs, convenience receptacles, and the point where they exit from the apparatus.
11. Only use attachments/accessories specified by the manufacturer.
12. Use only with the cart, stand, tripod, bracket, or table specified by the manufacturer, or sold with the apparatus. When a cart is used, use caution when moving the cart/apparatus combination to avoid injury from tip-over.



13. Unplug this apparatus during lightning storms or when unused for long periods of time.
14. Refer all servicing to qualified service personnel. Servicing is required when the apparatus has been damaged in any way, such as power-supply cord or plug is damaged, liquid has been spilled or objects have fallen into the apparatus, the apparatus has been exposed to rain or moisture, does not operate normally, or has been dropped.

### **Additional Safety Information!**

- This product should not be placed in a built-in installation such as a bookcase or rack unless proper ventilation is provided or the manufacturer's instructions have been adhered to.
- Apparatus shall not be exposed to dripping or splashing and that no objects filled with liquids, such as vases, shall be placed on the apparatus.
- When the switch is in the OFF position, the apparatus isn't completely switched-off from the MAINS.
- The equipment shall be installed near the power supply so that the power supply is easily accessible.
- Do not expose the unit to excessive heat such as direct sunlight, fire or the like.

**NOTE:**

This equipment has been tested and found to comply with the limits for a Class B digital device, pursuant to Part 15 of the FCC Rules. These limits are designed to provide reasonable protection against harmful interference in a residential installation. This equipment generates, uses and can radiate radio frequency energy and, if not installed and used in accordance with the instructions, may cause harmful interference to radio communications. However, there is no guarantee that interference will not occur in a particular installation. If this equipment does cause harmful interference to radio or television reception, which can be determined by turning the equipment off and on, the user is encour-

aged to try to correct the interference by one or more of the following measures:

- Reorient or relocate the receiving antenna.
- Increase the separation between the equipment and receiver.
- Connect the equipment into an outlet on a circuit different from that to which the receiver is connected.
- Consult the dealer or an experienced radio/TV technician for help.

**NOTE: Changes or modifications may cause this unit to fail to comply with Part 15 of the FCC Rules and may void the user's authority to operate the equipment.**

**This Class B digital apparatus complies with Canadian ICES-003.**

Cet appareil numerique de la Classe B est conforme a la norme NMB-003 du Canada.

---

---

**DECLARATION OF CONFORMITY**

---

---

This device complies with Part 15 of the FCC rules. Operation is subject to the following conditions: (1) This device may not cause harmful interference, and (2) this device must accept any interference received, including interference that may cause undesired operation.

**U.S. Responsible Party: Marantz America, Inc.  
100 Corporate Drive,  
Mahwah, NJ, 07430, U.S.A.  
TEL: 201-762-6500**

Type of Product: Super Audio CD Player  
Model: SA-7S1

---

---

OPT\_071203U2

## 保修

关于保修信息, 请与您当地的 Marantz 批发商联络。

## 保留您的购买收据

您的购买收据是您有价购买的永久记录。应当将它保存在安全的地方, 需要时可作为保险或与 Marantz 沟通时的凭证。

## 重要事项

当需要保修服务时, 消费者有责任提供购买的凭证及日期。您的购买收据或发票即可作为充分的凭证。

## 只适用于英国

这一承诺作为消费者法定权利的补充, 不能以任何方式改变这些法定权利。

## 警告

- 不要让本器材暴露于雨水、湿气、滴水或溅水之中。
- 不要移除本器材的外盖。
- 不要从通风孔将任何物品推入本器材内。
- 不要用潮湿的手处理主电源电线。
- 不要使诸如桌布、报纸、窗帘等任何物品遮盖住通风口。
- 不要将诸如点燃的蜡烛等明火火源置于本器材上。
- 当丢弃废旧的电池之前, 请遵守当地的政府法规及环境保护规则。
- 在放大器的各侧保留约0.1m的空间。
- 切勿将盛有液体的物品, 如花瓶, 置于本机上。
- 当开关位于OFF处时, 本设备并未完全与MAINS切断。
- 本设备应安装在电源附近, 以方便接上电源。
- 请不要让本装置暴露于直射阳光、火焰或类似过热热源。

OPT\_070719K1

## 「根据电子信息产品污染控制管理办法的有毒·有害物质或元素的标识表」

零部件名称	对象零部件	有毒有害物质或元素						备注
		铅 (Pb)	汞 (Hg)	镉 (Cd)	六价铬 (Cr6+)	多溴联苯 (PBB)	多溴二苯醚 (PBDE)	
电路板	电路板组件, 安装·插入零部件, 电路板 (不包括特定电子零部件)	×	○	×	○	○	○	
机芯单元	HDD、DVD、CD 等的机芯·激光组件	×	○	○	○	○	○	
机壳	顶盖底盖底壳框架垫片螺丝等 (金属, 塑胶), (包含的接合材料)	×	○	○	○	○	○	
显示器	FL, LCD 显示器,	×	○	○	○	○	○	
特定电子零部件	变压器, 插入物, 电源插座, 电源用大型电解质电容器等电子零部件, 机内连接线	×	○	○	○	○	○	
附件	遥控器 / AC 适配器、电源线、RCA 信号线等附件, 包装	×	○	○	○	○	○	

备注:

○: 在该零部件的所有物质材料中的有毒有害物质的含量不超过在 SJ/T11363-2006 标准规定的限量要求

×: 在该零部件中至少一种物质材料中的有毒有害物质的含量超过在 SJ/T11363-2006 标准规定的限量要求 (× 判定: 包括 EU RoHS 的豁免项目)



此标志是根据 2006/2/28 颁布的「电子信息产品污染控制管理办法」, 以及「电子信息产品污染控制标识要求」, 适用于在中国销售的电子信息产品的环保使用期限。

只要遵守此产品相关的安全和使用注意事项, 在从生产日期起计算的此年限内, 产品中的有害物质不会往外泄漏, 或者引起突然变异而给环境污染, 人体或财产带来重大影响。

另外, 包装在一起的电池等消耗品的环保期限的技术寿命为 5 年。

产品使用终结需废弃时, 请遵守当地的电子信息产品回收·再利用相关的法律·规定。

00D5114601002

# CONTENTS

FOREWORD .....	2
EQUIPMENT MAINS WORKING SETTING .....	2
COPYRIGHT .....	2
INTRODUCTION .....	2
PRODUCT FEATURES .....	3
ABOUT SUPER AUDIO .....	3
PLAYING CD-RW DISCS .....	3
APPLICABLE DISCS TO THE UNIT .....	3
BEFORE USING .....	4
NOTES ABOUT THE DISCS .....	4
INAPPROPRIATE PLACES FOR INSTALLATION .....	4
PRECAUTIONS .....	5
USING REMOTE CONTROL UNIT .....	5
LOADING BATTERIES .....	5
NAMES AND FUNCTIONS .....	6
FRONT PANEL .....	6
REMOTE CONTROLLER .....	7
REAR PANEL .....	9
DISPLAY .....	10
CONNECTIONS .....	11
OPERATION .....	12
CONNECTING THE POWER SUPPLY .....	12
NORMAL PLAYBACK .....	12
START SOUND MODE .....	14
MAKING YOUR FAVORITE AUDIO SETTINGS .....	14
PLAYING YOUR FAVORITE TRACKS OF A DISC .....	16
PLAYING YOUR FAVORITE PARTS OF A DISC (SEARCH) .....	16
REPEATED DISC PLAY .....	16
(REPEAT PLAY) .....	16
PLAYING TRACKS IN A RANDOM SEQUENCE (RANDOM PLAY) .....	17
PLAYING TRACKS IN A SPECIFIC SEQUENCE (PROGRAM PLAY) .....	17
SEARCHING YOUR FAVORITE TRACKS (AMS (AUTOMATIC MUSIC SCAN) PLAY) .....	18
QUICK REPLAY .....	19
ABOUT THE TEXT INFORMATION DISPLAY .....	19
SWITCHING OFF THE DISPLAY OR STAR MARK (DISPLAY (DISPLAY) OPERATIONS) .....	20
USING A MASTER CLOCK GENERATOR WHEN PLAYING DISCS .....	21
TIMER PLAY .....	22
ABOUT BALANCED JACKS .....	22
ANALOG OUTPUT CONNECTOR PHASE SWITCHING .....	22
TROUBLE SHOOTING .....	23
SPECIFICATIONS .....	24

## FOREWORD

This section must be read before any connection is made to the mains supply.

### EQUIPMENT MAINS WORKING SETTING

Your Marantz product has been prepared to comply with the household power and safety requirements that exist in your area.

- Power requirements (U.S.A.) ..... AC 120V 60Hz
- Power requirements (China) ..... AC 220V 50Hz

### COPYRIGHT

Recording and playback of any material may require consent. For further information refer to the following:

- Copyright Act 1956
- Dramatic and Musical Performers Act 1958
- Performers Protection Acts 1963 and 1972
- Any subsequent statutory enactments and orders

## INTRODUCTION

Thank you for selecting the Marantz SA-7S1 Super Audio CD Player for your Audio system.

This Player incorporates a number of features designed to enhance the listening of your favorite audio sources.

Please read these operating instructions carefully. We recommend that you read the entire user guide before you attempt to connect or operate the player.

After you have reviewed the contents of this manual, we suggest that you make all system connections before you attempt to operate the unit.

## INTRODUCTION

### PRODUCT FEATURES

This unit can playback the outstanding sound performance in Super Audio CD. This unit has the following unique features.

- Low-noise low-distortion filter circuit and high-speed HDAM SA2-type output amplifier with the differential input type HDAM.
- Text information display function that can display disc titles, track titles etc. in Super Audio CD.
- CD-R/CD-RW discs can be played.
- Discs can be played using an external high-precision clock.
- Phase inversion of analog signal can be performed.

### ABOUT SUPER AUDIO

The Super Audio standard is based on Direct Stream Digital (DSD) technology. This new direct-stream digital format comprises a 1-bit system that has a digital sampling frequency that is 64 times higher than that of conventional audio CD. The results are spectacular: a frequency response of over 100k Hz and a 120 dB dynamic range over the entire audible spectrum. Mixed with as many of the original frequencies as possible, the audio information audible for human ears sounds much more natural.

All audible frequencies are, after all, embedded in the frequency range as emitted by the sound source. A better reproduction does not exist! For the first time your ears will relive reality.

### PLAYING CD-RW DISCS

This unit can play back the CD-RW (ReWritable) discs as well as ordinary Audio CD and CD-R (Recordable) discs.

- The CD-R and CD-RW discs should contain properly-recorded TOC information so that they can be played back. In CD recorders, the task of writing TOC information is referred to as finalizing the disc. Discs that are not finalized cannot be properly recognized as an Audio CD and played back by regular CD players and Super Audio CD players. For details, please read the instruction manual provided with a CD recorder.
- \* TOC stands for Table Of Contents and contains information such as the total number of tracks and total playing time of the disc.
- This unit can play only the discs recorded in the CD-DA format designed for music reproduction. Do not attempt to play a disc containing other data, such as a CD-ROM for PCs, on this unit.
- As the playback of a CD-RW disc necessitates partial change of the player setup, it may take longer time for reading the TOC information than when an Audio CD or CD-R disc is played.

### APPLICABLE DISCS TO THE UNIT

#### 1. Super Audio CD



There are three types of Super Audio CDs.

- **Single-layer Disc**
- **Dual-layer Disc**
- **Hybrid-layer Disc**

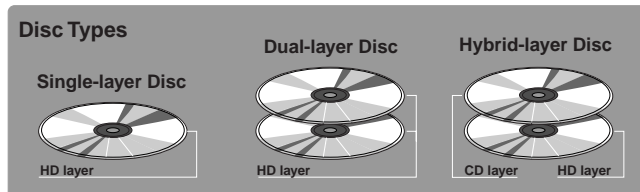

And each type may contain two areas of recorded information.

- **High quality stereo area**
- **High quality multi-channel area\*\***
- **Single Layer Disc**  
It can contain both high quality stereo area and high quality multi-channel area\*\* information.
- **Dual Layer Disc**  
It can contain both high quality stereo area and high quality multi-channel area\*\* information. And a double amount of information can be stored on the disc thanks to the second layer.
- **Hybrid Layer Disc**  
Not only does this disc contain both high sound quality stereo area and high sound quality multi-channel area\*\* information, it also has a CD layer in the second layer, so it can be played on a CD player.

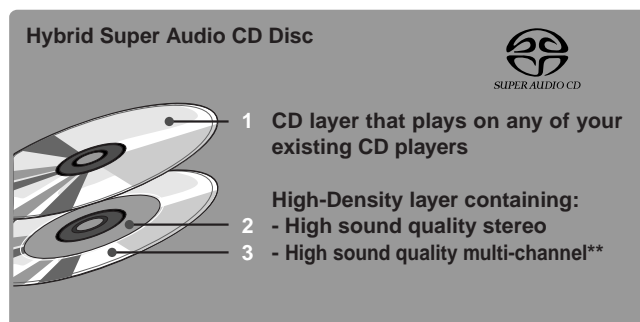

The number of tracks recorded may vary per layer. It will be shown on the display window of the unit.

\*\* This unit is a stereo-only player, and so it cannot play high-quality multi-channel audio areas. (It does not recognize multi-channel areas.)

#### 2. Audio CD (CDDA)



Audio CDs contain music tracks only.



# BEFORE USING

## NOTES ABOUT THE DISCS

\* Handle the discs carefully so as not to scratch their surfaces.

\* Keep the surfaces of the discs clean at all times.

When cleaning the surfaces of discs, always be sure to use the special cleaner and wipe the surfaces in the directions shown in the figure below.

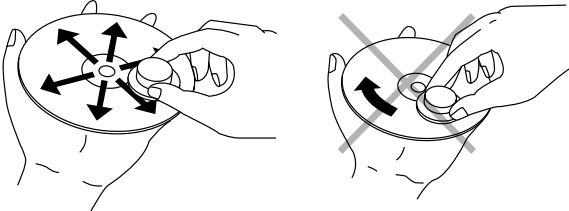

- Wipe the surface radially from the center.
- Do not wipe the surface in the circumferential direction.

\* Do not attach pieces of paper or stickers to the label surfaces of the discs.

When a disc has a piece of plastic tape or rental CD label with paste protruding from the edge or when a disc still bears traces of sticky tape or adhesive labels, do not attempt to play it. If such a disc is played on the CD player, you may find that you cannot remove it or that some other kind of malfunctioning may occur.

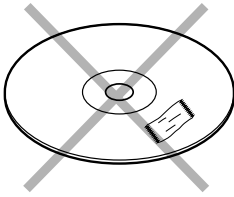

\* Do not use discs which come in special shapes.

Do not attempt to play heart-shaped or octagonal discs or discs with any other special shapes. You may find that you cannot remove them or that some other kind of malfunctioning may occur in the player.

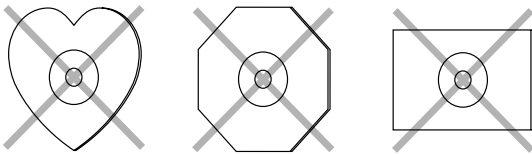

\* Use discs which satisfy the CD standards such as those with the "CD logo" or "Compact Disc Digital Audio" mark on their disc label surfaces.

No guarantees are made for playback if discs which do not satisfy the appropriate CD standards are used.

Similarly, no guarantees are made for their sound quality even if it is possible to play such discs.

\* To protect your discs from damage, avoid placing them in the following locations.

- Where they will be exposed to direct sunlight or where they will be close to a heater or other heat-radiating appliance
- Where the humidity level is high or it is very dusty
- Near a window or other such location where they may be exposed to rain

\* Get into the habit of putting the discs back in their cases after use.

## INAPPROPRIATE PLACES FOR INSTALLATION

To keep your player in perfect working order for the longest possible time, avoid installing the player in the following locations.

- Wherever it will be exposed to direct sunlight
  - Wherever it will be close to a heater or other heat-radiating appliance
  - Wherever the humidity is high or ventilation is poor
  - Wherever it is very dusty
  - Wherever it will be subject to vibration
  - On top of a rickety stand or in an unstable location which is tilted at an angle
  - In an audio rack with little space at the top and bottom or other location where the heat dissipation will be obstructed. To ensure proper heat dissipation, install the player while leaving clearances between the player and wall or other components, as shown in the figure below.
  - On top of an amplifier or other component which dissipates a great deal of heat
- \* The quality of the laser and other components can be harmed if the player is placed directly on top of an amplifier or other device which generates heat.

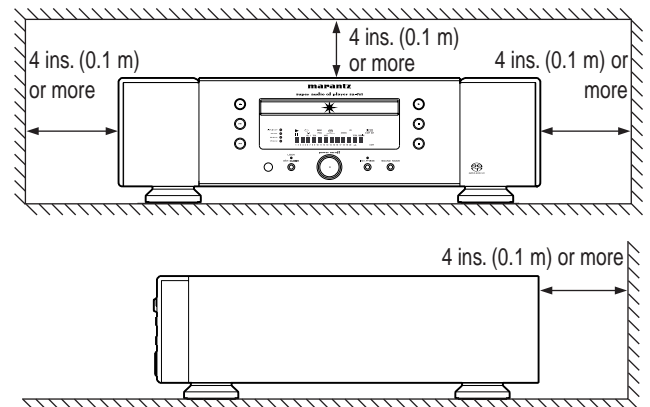

### ■ Do not place objects on top

- Refrain from placing any objects on top of the player.

### ■ Cautions on handling power cord

- Do not touch the power cord with wet hands.
- When disconnecting the power cord, always make sure that you take hold of the plug. Yanking out or bending the cord can damage it and/or cause electric shocks or a fire.
- Get into the habit of disconnecting the power plug before leaving home.

### ■ Do not attempt repairs yourself

- Refrain from lubricating the player: doing so can cause malfunctioning.
- Only qualified engineers with specialized expertise are authorized to repair the pick-up and parts inside the player.

## BEFORE USING

### PRECAUTIONS

- In winter, droplets of water form on the insides of the windows of a heated room: this is called condensation. This player uses an optical lens, so the condensation may form in the following cases.
  - In a room immediately after the heating has been turned on
  - In a room where the humidity level is high
  - When the player has been suddenly brought from a cold location into a warm room
 Since, in cases like this, the track numbers may not be read and the player is prevented from operating properly, wait about 30 minutes, and then operate the player.
- This player may cause interference on a tuner or TV set. If this is the case, place it further away from the tuner or TV set.
- Compact discs have much less noise than analog records and hardly any noise is heard before play starts. Bear in mind, therefore, that if the volume control on the amplifier is set too high, you will risk damaging other audio components.
- This player is designed to play Super Audio CD and normal Audio CDs only. It cannot play CD-ROMs used with personal computers, game CDs, video CDs or DVDs (video/audio).
- We do not recommend the use of lens cleaners.

### USING REMOTE CONTROL UNIT

#### Cautions on handling batteries

Misuse of the batteries can result in electrolyte leakage, rupturing, corrosion, etc.

Bear in mind the following points when using batteries.

- Remove the batteries from the remote control unit if the unit is not going to be used for a prolonged period (a month or more).
- Do not use an old battery together with a new one.
- Insert the batteries while ensuring that their  $\oplus$  and  $\ominus$  poles are properly aligned with the corresponding markings on the remote control unit.
- Batteries with the same shape may have different voltages. Do not use different types of batteries together.
- If electrolyte has leaked, thoroughly wipe the inside of the battery compartment, and then insert new batteries.
- When batteries which are no longer required are to be discarded, follow the directions (regulations) laid down by the local authorities in the area concerned for their disposal.

### LOADING BATTERIES

Batteries in this remote control unit have a life of approximately 1 year under normal operating conditions. If the remote control unit is not going to be used for an extended period of time, remove the batteries. Also, if you notice that the batteries are starting to run down, replace them as soon as possible.

- ① Remove the battery cover.

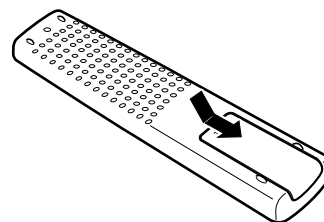

- ② Insert the batteries with correct +/- orientation.

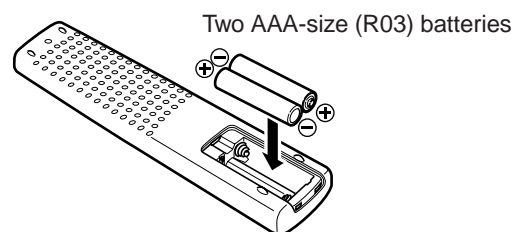

- ③ Close the battery cover until it clicks shut.

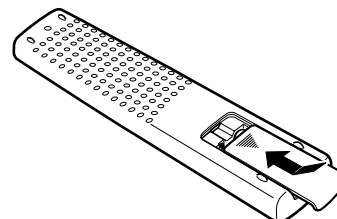

### Remote control

Operate the remote control unit within a distance of approx. 5 m from the infrared signal reception window (remote sensor) on the front of the Super Audio CD player.

Remote control operation may not be possible if the remote control unit's transmitter is not pointing in the direction of the remote sensor or if there is an obstruction between the transmitter and the remote sensor.

Remote control operating range

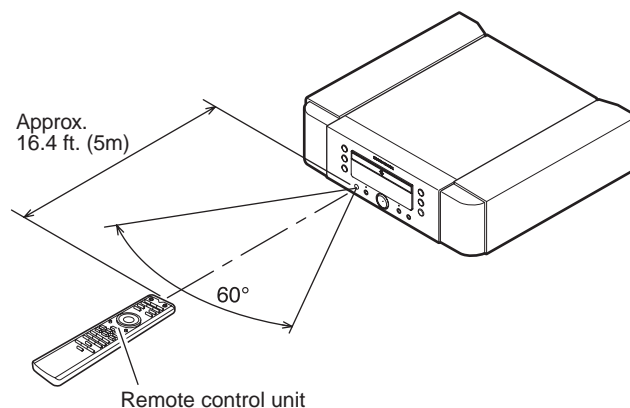

# NAMES AND FUNCTIONS

## FRONT PANEL

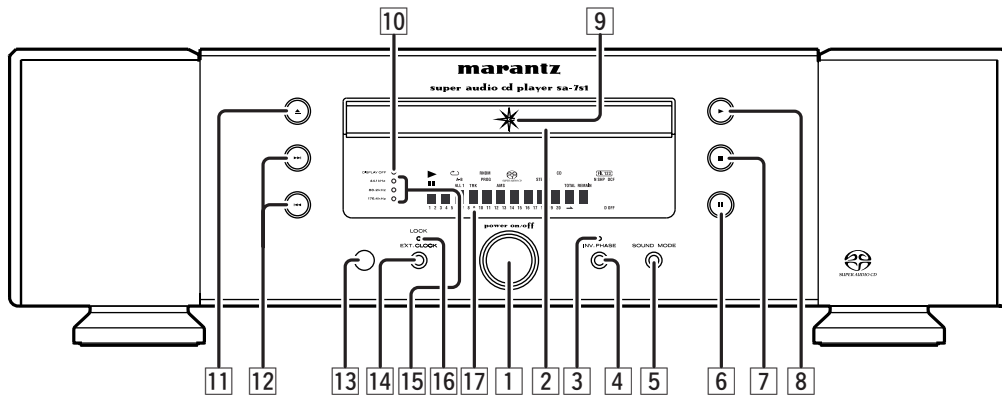

### 1 POWER ON/OFF switch

This switch is used to turn the power ON and OFF. When it is pressed, the display window lights up, and the power comes on. When it is pressed again, the display window is extinguished, and the power goes off.

### 2 Disc tray

The disc to be played is placed on the tray.  
\* Close the tray by pressing the operation button, not by pressing it in with your hand.

### 3 INV. PHASE (Inverted phase) indicator

This lights when the INV. PHASE button is pressed, and the phase of the signal from the ANALOG OUTPUTS connector (BALANCED, UNBALANCED) is being inverted.

### 4 INV. PHASE (Inverted phase) button

Press this button to invert the phase of the signal from the ANALOG OUTPUTS connector (BALANCED, UNBALANCED). (See page 22)

### 5 SOUND MODE button

Press this button to select the Super Audio CD sound mode. Super Audio CD (stereo) or Audio CD (if discs are supported) (See page 14)

### 6 PAUSE button

Press this button to pause playback. If pressed again, the unit returns to playback.

### 7 STOP button

Press this button to stop playback. Also this button is used to clear all programs.

### 8 PLAY button

Press this button to start playback.

### 9 Star mark

This turns on when the tray is closed.  
This star mark may always remain off for certain settings. (See page 20)

### 10 DISPLAY OFF indicator

This indicator turns on when the LCD screen is turned off (Off mode).

### 11 OPEN/CLOSE button

Press this button to open the tray. Put on a disk label side up. Press the button again to close the tray.

### 12 Track Skip/Search buttons

These buttons can be used as both track skip and track search buttons. (The buttons on the main unit only.)

◀◀ : When this button is pressed, the unit goes back to the beginning of the current track. If the button is pressed more times, the track being played is skipped back. When this button is held down, tracks are searched backward (Fast Rewind).

▶▶ : Each time this button is pressed, the track being played is skipped forward. When this button is held down, tracks are searched forward (Fast Forward).

In program play, Fast Forward and Fast Rewind can be done in the playing track only.

### 13 Remote sensor

The infrared control signal emitted from the remote control unit are sensed here.

### 14 EXT. CLOCK (External clock) button

Press this button to match the frequency with the master clock generator connected to the unit. (See page 21)

### 15 EXT. CLOCK (External clock) indicator

When the EXT. CLOCK button is pressed, one of the unit's clock frequency indicators (44.1 kHz, 88.2 kHz, 176.4 kHz) turns on.

Every time the EXT. CLOCK button is pressed, the clock frequency indicator changes. (See page 21)

\* When the 44.1kHz, 88.2kHz, and 176.4kHz indicators are all on at the same time, the internal memory is being reorganized. This is not a malfunction. Do not switch off the power during this process.

### 16 LOCK (lock) indicator

This turns on when the EXT. CLOCK button is pressed, and the EXT. CLOCK indicator clock frequency and the master clock generator clock frequency match (synchronize). (See page 21)

### 17 LCD

This screen shows the operating status.

# NAMES AND FUNCTIONS

## REMOTE CONTROLLER

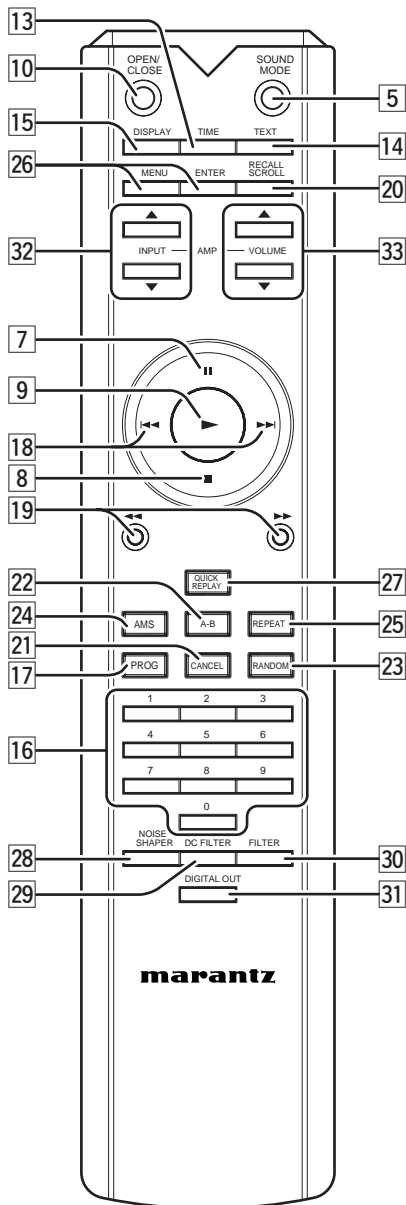

5 **SOUND MODE** button

7 **|| PAUSE** button

8 **■ STOP** button

9 **▶ PLAY** button

10 **▲ OPEN/CLOSE** button

The buttons listed above are the same to the buttons on the front panel of the main unit.

Please see the correspond items in "Front Panel" section.

13 **(TIME)** button

This button is used to switch from the text display to the time display when using a text-compatible Super Audio CD. It is also used to change the time display. Each time that it is pressed, the displayed time cycles from track elapsed time → track remaining time → total remaining time → track elapsed time . (See page 13)

14 **(TEXT)** button

This button is pressed to switch the main screen from the time display to the text display when using a text-compatible Super Audio CD. (See page 19)

15 **(DISPLAY)** button

This button switches the display screen on and off. The 10 indicator turns on when Display Off is set. (See page 20)

16 **(0) - (9) (Numerical buttons)**

Use these buttons to select tracks directory.

17 **(PROG.)** button

This button is for program play. (See page 17)

18 **◀◀, ▶▶ (Track skip buttons)**

◀◀ : When this button is pressed, the unit goes back to the beginning of the current track. If the button is pressed more times, the track being played is skipped back.

▶▶ : Each time this button is pressed, the track being played is skipped forward.

\* Search buttons are provided separately for the remote control unit. Use 19 Search buttons for search function.

19 **◀◀, ▶▶ (Search buttons)**

◀◀ : While this button is pressed during playback, tracks are searched backward.

▶▶ : While this button is pressed during playback, tracks are searched forward.

20 **(RECALL/SCROLL)** button

Use this button to scroll text while displaying text information in a Super Audio CD disc that supports TEXT. This button is also used for checking the programmed tracks during a program or when a program is stopped. (See page 18)

21 **(CANCEL)** button

Use this button to cancel a programmed track. (See page 18)

22 **(A-B) (A-B Repeat button)**

This button is to determine starting and ending points for A-B repeat play. (See page 16)

23 **(RANDOM)** button

This button is for random play. (See page 17)

\* In this instruction manual, some operations can only be performed with the remote control. For operations that can be performed with buttons both on the main unit and on the remote control, the button names are shown in the  mark. And for operations that can only be performed with buttons on the remote control, the button names are shown in the  mark.

## NAMES AND FUNCTIONS

### 24 **AMS (Automatic Music Scan button)**

Use this button for AMS play. (See page 18)

### 25 **REPEAT button**

This button is for repeat play. Each time this button is pressed, repeat mode changes as follows. "All Repeat" → "Track Repeat" → "Repeat Off" (See page 16)

### 26 **MENU button and ENTER button (Menu setup)**

These buttons are used to set the time for quick replay. (See page 19)

### 27 **QUICK REPLAY (Quick replay) button**

This button is used to do quick replay of the tracks. (See page 19)

### 28 **NOISE SHAPER button**

This button is pressed to turn the noise shaper on and off. (See page 14)

### 29 **DC FILTER button**

This button is pressed to turn the DC filter on and off. (See page 14)

### 30 **FILTER button**

This button is pressed to make the digital filter settings. Each time it is pressed, the settings cycle from FIL1 → FIL2 → FIL3 → FIL1. (See page 15)

### 31 **DIGITAL OUT button**

This button is pressed to turn the digital output for the Audio CD signal on and off. (See page 14)

### 32 **INPUT button**

This button is pressed to switch the input when using one of the supported Marantz amplifiers (supported models as of September 2006: SC-7S2, PM-11S1, PM-15S1, PM7001, SR9600).

### 33 **VOLUME button**

This button can be used to adjust the volume when a Marantz amplifier that has a remote control is used.

**NAMES AND FUNCTIONS**

**REAR PANEL**

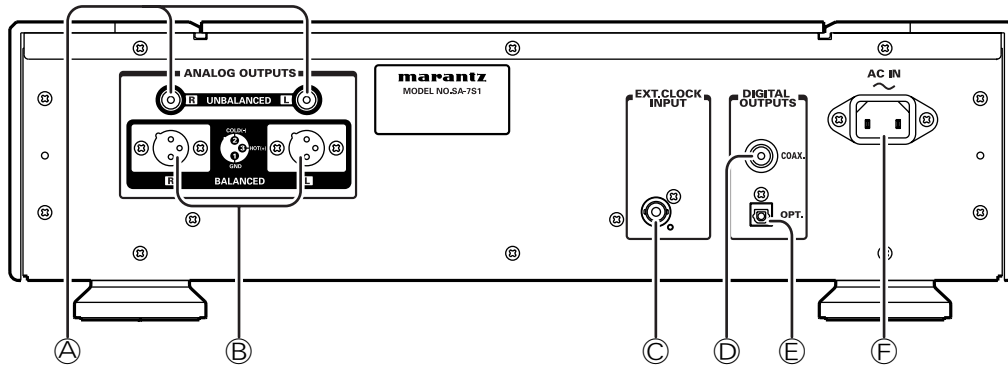

**(A) ANALOG OUTPUTS UNBALANCED connectors**

These are the unbalanced output jacks of the analog audio signals. The analog connection cord can be connected to the CD, AUX, or other connectors on an amplifier. Be sure to connect the L and R channels correctly to the corresponding jacks.

\* Never connect to the PHONO connector on the amplifier.

**(B) ANALOG OUTPUTS BALANCED connectors**

These are the balanced output jacks of the analog audio signals. A balanced connection cord (available commercially) can be connected to the balanced input jack of the amplifier. Be sure to connect the L and R channels correctly to the corresponding jack. (See page 22)

\* If connecting the balanced output jacks, be sure to leave the unbalanced jacks unconnected. (The balanced and unbalanced connectors cannot be used at the same time.)

**(C) EXT. CLOCK INPUT (External clock) Connector**

This is the input connector for the clock frequency from an external master clock generator. Connect the master clock generator to the BNC terminal coaxial cable (75 Ω).

**(D) DIGITAL OUTPUTS COAX. (Coaxial digital output connector)**

The audio CD signal being played is output digitally. Connect a recording device, amp, D/A converter etc. that has a coaxial digital input connector using a commercially available coaxial cable.

\* No signal is output when Digital Out OFF is set.  
\* No signal is output when playing a super audio CD.

**(E) DIGITAL OUTPUTS OPT. (Optical digital output connector)**

The audio CD signal being played is output digitally. Connect a recording device, amp, D/A converter etc. that has an optical digital input connector using a commercially available square-shaped optical cable.

\* No signal is output when Digital Out OFF is set.  
\* No signal is output when playing a super audio CD.

**(F) AC POWER INPUT JACK**

Connect the supplied power cord to this jack and a household AC power outlet.

## NAMES AND FUNCTIONS

### DISPLAY

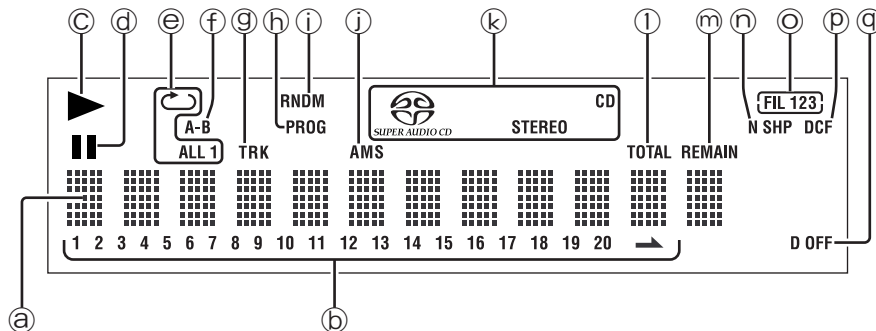

#### Ⓐ Main display

The time display and text information of the disc to be played as well as the setting menus and other displays appear on the main display.

#### Ⓑ 1-20, ➡ (music calendar)

The number of tracks recorded on the disc to be played, the number of remaining tracks to be played, and the number of tracks programmed by program play appear here. "➡" light when 21 or more tracks have been recorded on the disc.

#### Ⓒ ▶ (play) indicator

This lights during disc play.

#### Ⓓ || (pause) indicator

This lights when play is paused (temporarily stopped).

#### Ⓔ ↺, ALL, 1 (repeat) indicator

This lights during repeat play.

#### Ⓕ A-B (A-B repeat) indicator

This lights during A-B repeat play.

#### Ⓖ TRK (track) indicator

This lights above the display of the track number now playing, for instance.

#### Ⓗ PROG (program) indicator

This lights during program play.

#### Ⓘ RNDM (random) indicator

This lights during random play.

#### Ⓙ AMS (automatic music scan) indicator

This lights during AMS playback.

#### Ⓚ CD, Super Audio CD, STEREO Disc indicator

This indicates the type of disc on the disc tray.

#### Ⓛ TOTAL (total time) indicator

When the total remaining time or the total program time is displayed, this lights above the display.

#### Ⓜ REMAIN (remaining time) indicator

When the remaining playback time of a track is displayed, this lights above the display.

#### Ⓝ N SHP (noise shaper) indicator

This lights when the noise shaper is turned on. (See page 14)

#### Ⓞ FIL 1 2 3 (filter 1, filter 2, filter 3) indicator

This indicates which filter among filter 1, filter 2, or filter 3 is currently selected. (See page 15)

#### Ⓟ DCF (DC filter) indicator

This lights when the DC filter is turned on. (See page 14)

#### Ⓠ D OFF (digital output off) indicator

This lights when the digital output setting for the CD signal is set to off. (See page 14)

# CONNECTIONS

Depending on your amplifier/receiver/Stereo System, there are various ways to connect to this player. For correct connection please refer to instruction manuals of stereo system to be connected.

Caution: Do not connect output from this unit to PHONO input of your audio system.

1. Connect the audio cable ① to this unit's front speaker outputs and the stereo inputs on your amplifier, receiver or stereo system.
2. Connect the optical cable ②, coaxial cable ③ to the digital input on your AV amplifier, D/A converter, CD-R, etc..
  - \* Signal will be output from the digital audio out jacks (OPT./COAX.) only when an Audio CD disc is played. No signal is output when playing a Super Audio CD.
3. When connecting to an external master clock generator, use the BNC terminal coaxial cable (75Ω) ④.
  - \* Signals are output from the DIGITAL OUTPUTS connector (OPT., COAX.) only when an audio CD is being played. No signal is output when playing a super audio CD.

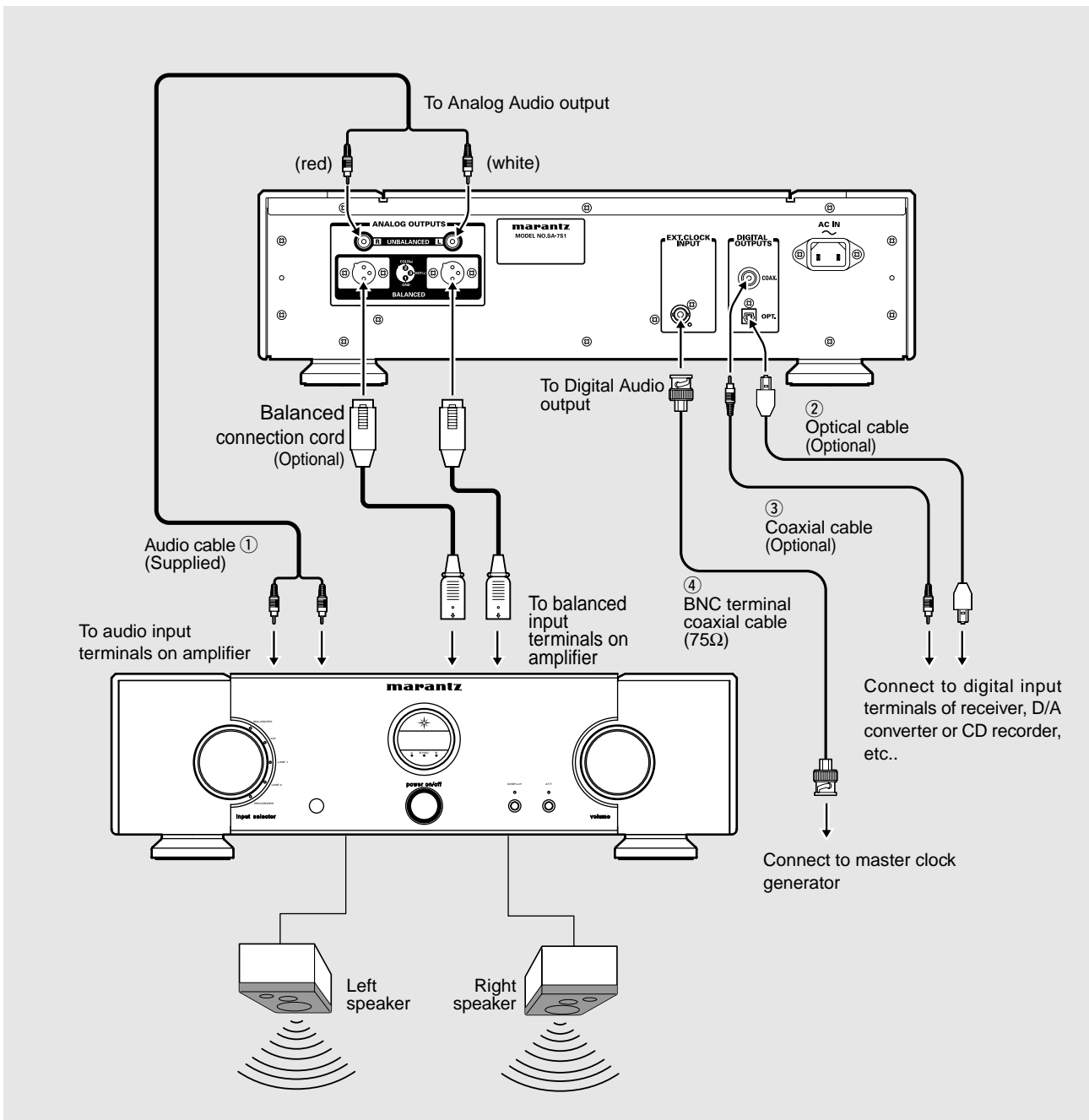



# OPERATION

\* In this instruction manual, some operations can only be performed with the remote control. For operations that can be performed with buttons both on the main unit and on the remote control, the button names are shown in the  mark. And for operations that can only be performed with buttons on the remote control, the button names are shown in the  mark.

## CONNECTING THE POWER SUPPLY

- 1 Plug the power cable into AC IN jack on the back panel.

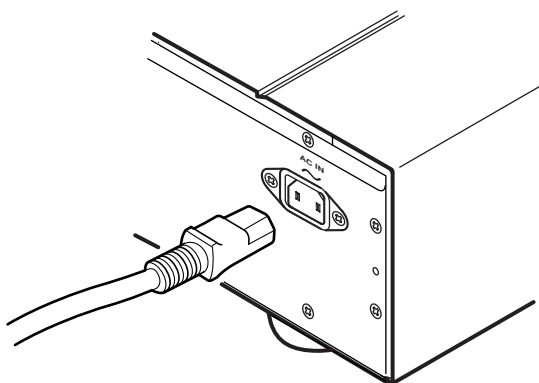

- 2 Turn on the power switch of the audio unit (amplifier, etc.) that is connected with this unit. Set the selector on the connected unit to this unit.
- 3 Plug the power cable into an AC outlet.

## NORMAL PLAYBACK

### ■ Super Audio CD player playback

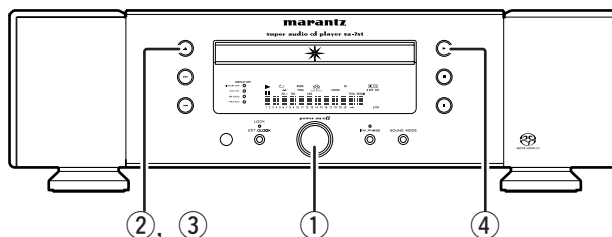

- ① Press **POWER** switch to turn on.

LCD

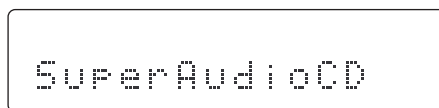

The display cycles from TOC Reading → No Disc (when no disc is loaded) → Super Audio CD (when the start sound mode setting is Super Audio CD).

- ② Press the  **OPEN/CLOSE** button

The disc tray comes out. Place the disc with label side up on the tray.

To play a single (8cm) CD, place the disc with the indentation at the center of the tray.

- ③ Press  **OPEN/CLOSE** button.

- ④ Press  **PLAY** button.

Disc type is automatically detected and playback is started. Track number and track elapsed time (minute, second) appear on the display.

\* For Super Audio CD/CD hybrid-layer discs (See page 3), the layer that is set in the start sound mode (See page 14) is played. To change the layer, use the  **SOUND MODE** button. (See page 14)

(Exp.: Track 6, Elapsed time 2 min 8 sec)

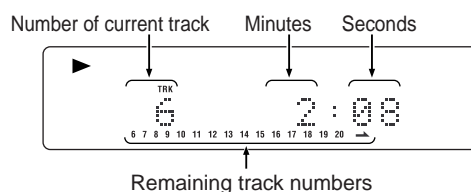

Playback automatically stops at the end of the final track.

## OPERATION

### To start playback from the first track

Press **▶PLAY** button.

### To stop playback

Press **■STOP** button.

### To eject disc

Press **▲OPEN/CLOSE** button to open the disc tray and take the disc off. Press the button again to close the tray. Disc tray must be closed when the unit is not be used.

### To pause playback

Press **⏸PAUSE** button.

PAUSE indicator will light and playback is paused at the point that the button is pressed. To restart playback, press **⏸PAUSE** button again or press **▶PLAY** button.

### To change time display

Press the **(TIME)** button on the remote control.

Each time **(TIME)** button is pressed, display will change in the following order. "Track elapsed time" → "Track remaining time" → "Total remaining time" → "Track elapsed time".

#### • Track remaining time

(The remaining playing time from the playing point to the end of the current track)



#### • Total remaining time

(The remaining playing time from the playing point to the end of the last track)

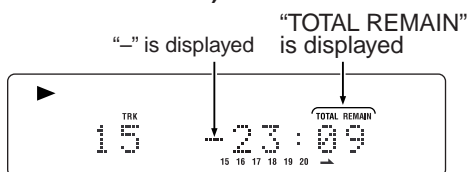

\* If **(TIME)** button is pressed when Super Audio CD disc that supports text is in use, time display is given priority and the text information will not be displayed afterward. To see the text information, press **(TEXT)** button.

## ■ Switching Sound Mode (Super Audio CD)

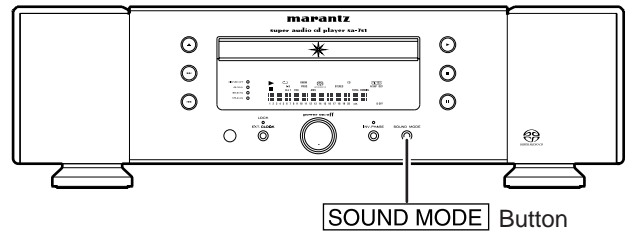

### ① Press **SOUND MODE** button in stop mode (not playing).

The currently selected layer or area is shown on the LCD. (CD or Super Audio CD)

If **SOUND MODE** button is pressed again, a playable layer or area will be shown, and the layer or area will be switched to new one.

\* When layer or area is switched, TOC will be read again.  
\* The sound mode cannot be changed for Audio CDs and discs with only a Super Audio CD area.

\* The sound mode on hybrid layer discs will be changed in the following order.

Super Audio CD stereo area → CD layer → Super Audio CD stereo area

\* Sound mode can be selected while the tray is open. Select a desired layer or area and press **▶PLAY** button then the tray will close and playback will be started.

### ② Press the **SOUND MODE** button during playback.

The currently selected layer or area is shown on the LCD. (CD or Super Audio CD)

If **SOUND MODE** button is pressed again, the playback is stopped, and the layer or area will be switched to new one. When you want to listen at that area, press **▶PLAY** button again. The playback will be started.

## OPERATION

## START SOUND MODE

When a Super Audio CD hybrid layer discs that has both a Super Audio CD high sound quality stereo area and an Audio CD area information are to be played, this player makes it possible to set the layer/area (Super Audio CD or Audio CD) to be preferentially played.

This setting can be made when the tray is closed and there is no disc in the disc tray.

- ① Press **[SOUND MODE]** button on the player.  
The currently selected layer/area is displayed.  
If the Super Audio CD is selected : Super Audio CD  
If the Audio CD is selected : CD
- ② Press the **[SOUND MODE]** button again to display the layer/area to be played first, and then leave the setting for at least two seconds to register the setting for the start sound mode.

**Caution**

- \* Start sound mode has a memory retention function where the settings remain stored and unchanged even when the disc is changed or the power is turned off.
- \* At the time of shipment, the sound mode is set to Super Audio CD.

## MAKING YOUR FAVORITE AUDIO SETTINGS

The settings can be made using the remote control. The settings are retained even if the power is turned off so that you can always enjoy tracks with your favorite characteristics. To change the settings again, make the changes using the same procedure. The settings can be changed when the track is stopped.

## ■ Playing the CD layer of an audio CD or Super Audio CD

### ① Noise shaper operation

In this unit, you can select noise shaper on or off for playing tracks.

The noise shaper is turned on and off by pressing the **[NOISE SHAPER]** button while the track is stopped. When turned on, the NSHP indicator lights up on the LCD.

- \* Noise shaping is a type of digital feedback used in the algorithms for oversampling. Digital feedback improves the linearity of bass sounds and the noise characteristics of the audio frequency band. However, this digital feedback is still feedback nonetheless. Generally, in amplifiers and other equipment, the sound quality changes based on the amount of feedback. Low feedback is said to result in poor audio characteristics but good sound. Although no measurement differences are shown in the SA-7S1, the sound quality is changed. Therefore, make the setting according to your preferences.

### ② DC filter operation

The DC filter is turned on and off by pressing the **[DC FILTER]** button while the track is stopped. When turned on, the DCF indicator lights up on the LCD.

- \* The DC filter is effective when the speakers vibrate abnormally for discs with recorded audio having extremely low noise characteristics. (The cutoff frequency is set to 1.7Hz.)

### ③ Digital output off operation

The digital output function is turned on and off by pressing the **[DIGITAL OUT]** button while the track is stopped. When digital output is turned off, the D OFF indicator lights up on the LCD.

- \* When digital output is not used, setting to digital output off enables you to enjoy better sound quality.

**Note**

- \* The noise shaper, DC filter, and digital output off have a memory retention function where the settings remain stored and unchanged even when the disc is changed or the power is turned off.

## OPERATION

### ■ Filters

The SA-7S1 is equipped with the "PEC 777f2" filter, developed with an improved algorithm from the digital filter for CD playback "PEC777f" (Phase Error Compensation 777 filter) that uses Marantz original DSP.

When playing a super audio CD, the D/A converter internal filter is used.

The filter has 3 types of built-in characteristics for both Audio CDs and Super Audio CDs, and the characteristics for each are shown in the table below. Change these settings according to your own personal preference.

### ■ Filter operations

The filter settings can be made while the track is stopped. The filters shown in the table below are available for providing distinctive filtering according to the operation and Audio CD or Super Audio CD.

Each time the **(FILTER)** button is pressed, the filter types cycle from FIL1 → FIL2 → FIL3 → FIL1.

The filter setting has a memory retention function so that the setting remains stored and unchanged even when the disc is changed or the power is turned off.

**Filter Selection Table**

Filter type	Audio CD	Super Audio CD
FILTER 1	This filter has short pre-echo and post echo characteristics. It carries a lot of sound information; therefore very profound sound image and a clear sound source are reproduced.	This is a direct mode that does not perform any filtering on the DSD data. The original source data is reproduced without any alteration.
FILTER 2	This characteristic is known as asymmetrical impulse response. The post echo is slightly longer than the pre-echo. The analog characteristics are slow roll-off characteristics, with well-balanced reproduction.	This filter dampens the section of DSD data that exceeds 100kHz. Also, operations within DAC are made asymmetrical, priority is given to DAC resolution, and the equivalent of 40 multi-levels are achieved.
FILTER 3	Impulse response is the shortest characteristic of these filters. It provides high sound definition along with a comfortable playback balance.	This filter attenuates sections of the DSD data that exceed 100kHz. In the DAC, it provides fully symmetric operation for 23 multi-levels.

Note: When playing back the high sound quality stereo area in Super Audio CDs, the analog output level varies slightly in each filter.

## OPERATION

## PLAYING YOUR FAVORITE TRACKS OF A DISC

### ■ Specify track number to play (Direct Search)

Specify track number with numerical buttons (0-9) on the remote  
(example)

3rd track : Press ③.

12th track : Press ① and then press ② (within approximately 1.5 seconds).

If the first pressed number is only in the digit of ones and not in the digit of tens, search begins approximately 0.5 second after.

#### ■ If a wrong number is pressed

Press correct number again.

\* If a track number that is not in the disc is specified, "No Track" will be shown on the main display. Please specify a correct track.

### ■ Skipping to the previous or next track (Track Skip)

**To listen to a track posterior to the current track**





Press the  button on the remote or the unit the same number of times as the number of tracks you want to advance.

**To listen to a track prior to the current track**

If the  button is pressed on the unit or the remote while playing a track, playback starts again from the start of the current track.

Continue to press the  button for the same number of times as the number of tracks you want to return.

## PLAYING YOUR FAVORITE PARTS OF A DISC (SEARCH)

If ,  buttons on the main unit or ,  buttons on the remote are kept pressing during playback, track search begins. Release the button when the point you want to listen to gets close.

\* No sound is output during the search operation.

## REPEATED DISC PLAY (REPEAT PLAY)

### ■ All track repeat

When  button on the remote is pressed, "ALL" indicator will light up and all track repeat play begins.

#### To Return to Normal Play

Press  button two times. "ALL" indicator will disappear, repeat mode will be off and it returns to normal play mode.

\* If  button is pressed when in program mode, programmed tracks are played repeatedly.

### ■ One Track Repeat

Press  button on the remote two times.

"1", "1" indicators will light and the track will be played repeatedly.

#### To Exit from One Track Repeat

Press  button. "1" indicator will disappear, repeat mode will be off and it returns to normal play mode.

### ■ A-B Repeat

① Press  button on the remote at your chosen starting point. The "A-" indicator will blink.

② Press  button again at your chosen end point. "A-B" indicator will light up and the chosen section will be played repeatedly.

#### To Exit from A-B Repeat

Press  button on the remote. "A-B" indicator will disappear, A-B repeat mode will be off and it returns to normal play mode.

\* A-B repeat cannot be done when random play is going on.

\* The end point (where "A-" indicator is blinks) of the repeat section cannot be set before the time of the starting point (where "A-B" indicator light up) of the repeat section.

**PLAYING TRACKS IN A RANDOM SEQUENCE (RANDOM PLAY)**

When **(RANDOM)** button on the remote is pressed in stop mode, and then **(▶PLAY)** button is pressed, the unit shuffles track order automatically and plays all the tracks in the shuffled order. The RNDM (random) indicator lights.

- The gap between tracks will be approximately 2 seconds during random play.

**To Exit from Random Play and Return to Normal Play**

Press the **(■STOP)** button, and then press the **(RANDOM)** button while playback is stopped.

The RNDM (random) indicator goes off, and random play is released.

**If **(▶▶)** buttons on the main unit or **(▶▶)** button on the remote are Pressed during Random Play**

It jumps to the next track of the shuffled order.

**If **(◀◀)**, **(▶▶)** buttons on the main unit or **(◀◀)**, **(▶▶)** buttons on the remote are Pressed during Random Play**

Search will be done only in the current track. Search does not go to the previous or next track.

**To Listen to Random Play Repeatedly**

Press **(REPEAT)** button on the remote once during random play. Every time the order will be shuffled.

- If **(RANDOM)** button is pressed during program play, the programmed tracks will be shuffled.

**PLAYING TRACKS IN A SPECIFIC SEQUENCE (PROGRAM PLAY)**

You can arrange and play tracks in a specific sequence. Up to 30 tracks to be played can be programmed.

**(Example: To program the 7th track after 15th track in a disc with 25 tracks)**

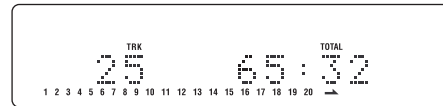

- 1 Press **(PROG)** button on the remote in stop mode. "PROG" indicator will blink and it goes to program mode.

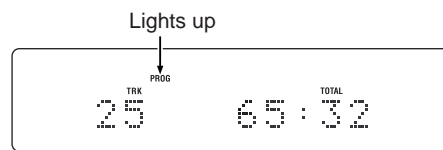

- 2 Choose a track to be programmed with numeric buttons on the remote.

**(Example: The 15th track is chosen and it's length is 4min30sec)**

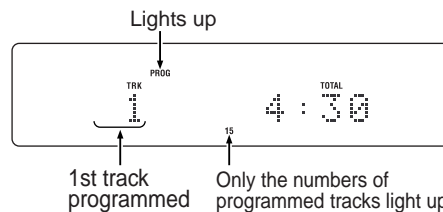

- 3 With the sequence described in step 2 above, program another track. Repeat that sequence to program all the tracks you want. You can program up to 30 tracks.

**(Example: The 7th track is chosen and total length of 7th and 15th is 7min50sec)**

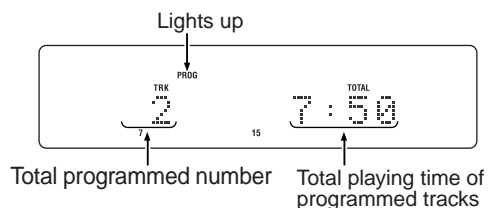

- 4 Press **(▶PLAY)** button to starts playback in programmed order.

\* When 21 or more tracks are programmed, **(▶)** will light up instead of the track number indicator.

## OPERATION

### To Check the Programmed Tracks

Press the **RECALL/SCROLL** button on the remote control during the program or when the program is stopped ("PROG" lights up).

Every time press **RECALL/SCROLL** button, the programmed tracks will be displayed one after the other in order.

### To Delete a Programmed Track

- ① Press **CANCEL** button in stop mode when program has been made (When "PROG" indicator is lighting up).
- ② Every time press **CANCEL** button, the programmed tracks are deleted in order from the last track programmed. Also, the deleted track's track number indicator will disappear.

### To Clear Whole Program

Press **STOP** button two times while in program play. In the stop mode, press **STOP** button once.

Program can also be cleared by pressing **OPEN/CLOSE** key to open the disc tray.

### To Add Tracks to Program

Tracks can be added to the end of program when program is remaining ("PROG" indicator is lighting up) and in stop mode. However tracks cannot be added to the program when the RNDM (random) indicator is lit up.

#### \* Please be careful about the following matters.

- When programming 1st through 9th tracks in a disc that has over 10 tracks by using numeric buttons. For instance, programming the 3rd track after programming the 1st track, press 3 button more than approximately 1.5 seconds after 1 button is pressed. When a program is finalized, the time is updated.
- Likewise, when programming a track at 10th or after. For example, to program 13th track, press 3 button within approximately 1.5 seconds after 1 button is pressed.
- When programming a track in a disc that has less than 9 tracks. For instance, to program the 5th track after 4th track has been programmed, press 5 button more than approximately 0.5 second after 4 button is pressed.

## Q&A

- **How many tracks can be programmed?**  
Up to 30 tracks can be programmed for program play.
- **Can I listen to program play repeatedly?**  
Press **REPEAT** button once. "ALL" indicator will light and program play will be repeated.
- **Can I shuffle the programmed track order?**  
Press **RANDOM** button in stop mode.

## SEARCHING YOUR FAVORITE TRACKS (AMS (AUTOMATIC MUSIC SCAN) PLAY)

This feature is convenient to search where your favorite track is.

If the **AMS** button is pressed while a track is stopped, the AMS indicator lights up, and the first ten seconds of each track on the disc will be played starting from the first track.

Also, if the **AMS** button is pressed during playback, the AMS indicator lights up, and the program jumps to the next track after approximately 10 seconds elapses on the display time.

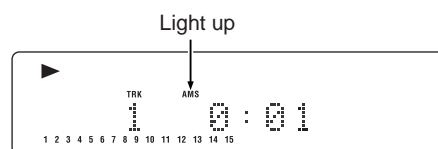

Once you find a song that you want to listen to, press the **AMS** button again or press the **PLAY** button. The AMS indicator turns off, and normal playback resumes from the current track.

\* If the **AMS** button is pressed after the tracks are programmed, only the programmed tracks are played by AMS.

## OPERATION

### QUICK REPLAY

When **QUICK REPLAY** button is pressed during playback, the unit goes back to the amount of time set by the MENU and starts playback from there.

\* Playback that goes beyond the track is not allowed.

Also, when the total time of the track being played is shorter than the time set for quick replay, or when the playback time is shorter than the time set for quick replay, if **QUICK REPLAY** button is pressed, the track will be goes back to the start of that track and playback is started from there.

#### To Set Quick Replay Time

- ① If a disc is loaded in the disc tray, eject the disc and close the tray.
- ② Press the **MENU** button on the remote control.



- ③ Press the **ENTER** button on the remote control while Quick Replay is displayed (approx. 3 seconds). The current time setting appears on the LCD. (The default setting is 10 seconds.)

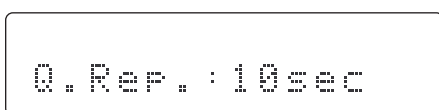

- ④ Use the **◀◀** or **▶▶** button to set the time. (5 to 60 seconds)
- ⑤ After making the setting, press the **MENU** button twice. The LCD returns to the normal display.
- ⑥ The time setting is retained even when the power is turned off.

#### Caution:

\* When there is no key input for about 3 seconds during this series of operations, the setting will be configured to the conditions at that time and the display will return the time display.

### ABOUT THE TEXT INFORMATION DISPLAY

The following items of text information in Super Audio CD discs can be displayed by pressing **TEXT** button on the remote. Nevertheless, which items of information are recorded depends on discs so some information may not be displayed. This unit skips unrecorded information to display.

#### • During playback

When **TEXT** button is pressed on the remote, "Track Title" of the currently playing will be displayed.

#### • In Stop Mode

Each time **TEXT** button on the remote is pressed, text information will be displayed in the following order.

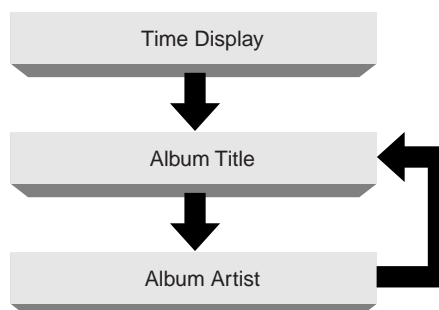

- This unit can display 12 characters in one time. If information is longer than 12 characters, the display will scroll right to left.
- This unit can display only alphabets, numeric numbers and symbols. Chinese and Japanese characters cannot be displayed. If information is in Chinese and Japanese characters, the unit displays nothing.



## OPERATION

## SWITCHING OFF THE DISPLAY OR STAR MARK (DISPLAY OPERATIONS)

During playback, the LCD display and each indicator can be turned off.

There are 2 display conditions (modes).

1. In this mode, the LCD display and all of the indicators are switched on and off in connection with the star mark.  
When the **DISPLAY** button is pressed during playback, the LCD display and all of the indicators are switched between ON (display on) and OFF (display off).  
When display off is set, the display off indicator (red) switches on.  
\* When the operating status is intentionally changed (for example, when the **OPEN/CLOSE** button, **STOP** button, or **PAUSE** button is pressed), the LCD display switches on automatically. However, the display off indicator (red) remains on at this time. Furthermore, approximately 2 seconds after playback has started in this condition, the LCD display automatically switches off.  
\* When the display is set to off while playback is stopped, the star mark and all of the indicators switch off, and the display off indicator switches on. At this time, the LCD display is switched on. Approximately 2 seconds after playback starts, it automatically switches off.
2. In this mode, the star mark is always off, and the LCD display and all other indicators except for the star mark are switched on and off. The star mark is switched on as a factory preset setting. This star mark is always switched off with no connection to the display on/off operation.

**To change the mode (mode settings cannot be changed during playback.)**

- ① If a disc is being played, press the **STOP** button to stop playback.  
Press and hold the **DISPLAY** button on the remote control for more than 2 seconds to operate the settings.
- ② If the star mark is currently on, it is switched off and set to off.

If you want to change the settings from the off setting to the on setting, press and hold the **DISPLAY** button again for longer than 2 seconds to change to the on setting.

\* The star mark off setting is saved even if the power is switched off, and it remains off until the settings are changed again to switch the star mark back on.

\* The display off settings are not saved when the power is switched off.

(You can enjoy using the display every time an operation is performed.)

\* The flashing LOCK indicator does not switch off even if display off is set. (See page 22)

**USING A MASTER CLOCK GENERATOR WHEN PLAYING DISCS**

**The master clock generator**

In digital devices such as CD players or super audio CDs, there is a process that samples or restores the analog signal. In order to conduct this process, a clock signal (sampling frequency) is used.

A master clock generator is an oscillation device that makes this clock signal.

The clock signal output by the crystal oscillator built into this unit is extremely accurate, enabling you to fully enjoy high quality sound playback. However, you can also perform playback using the clock signal output from an external master clock generator, to enjoy the difference in the sound that the master clock generator can provide.

In recent years, research has found that the difference in clock signals causes differences in tone quality. In response to this finding, many companies have released master clock generators.

Generally speaking, the more precise the clock signal time base is, the closer it is to the natural time base of the sound, thus enabling the reproduction of higher fidelity sound.

Therefore many master clock generators insist that they are capable of outputting a highly precise clock signal.

Anyway, the different clock seems give differences sound tone. This unit offers the possibility of enjoying the change.

The frequency of the clock signal that can be input into this unit is 44.1, 88.2, or 176.4kHz. Use a master clock generator that is capable of outputting these signals.

**■ Using a master clock generator for playback**

Should you elect to use an outboard master clock generator, be sure to select one that has an extremely accurate clock to avoid degrading the sonic performance of your SA-7S1.

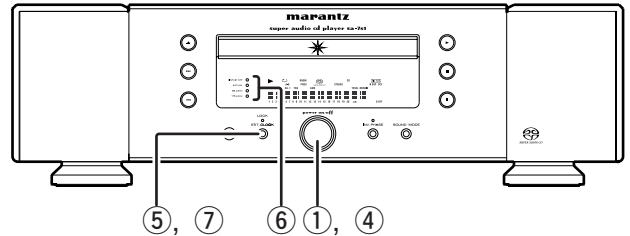

- ① Switch off the power supply.
- ② Connect the EXT. CLOCK INPUT connector on the rear of this unit to the output connector of the master clock generator using a commercially available BNC terminal coaxial cable. (See page 11)
- ③ Switch on the power of the master clock generator, and check the clock frequency to set. For details on this operation, please refer to the instruction manual that came with your master clock generator.
- ④ Press the POWER switch on this unit to switch on the power supply.
- ⑤ When the unit's LCD display is on, press the EXT. CLOCK button on the front of the unit.
- ⑥ Each time the EXT. CLOCK button is pressed, the clock frequency indicator lights in the window, in the order shown below.

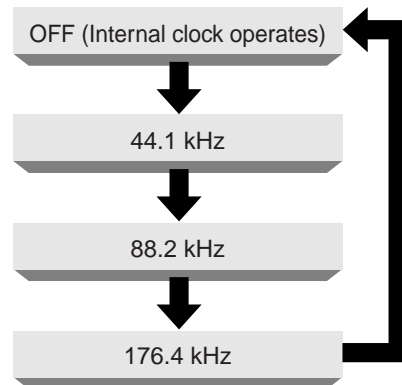

- ⑦ Press the EXT. CLOCK button to match the frequency with the clock frequency set in the master clock generator, and when the LOCK indicator switches on, the settings are complete.

You will be able to hear the changes in sound quality by changing the clock signal. Set the frequency to your own personal tastes.

**Caution**

- Switch between the master clock generator and the internal clock when playback is stopped to prevent excessive sound occurrence from the speaker.
- Sound will be muted when the LOCK indicator blinks. Check the settings of your master clock generator, the connections etc. During this time, the DIGITAL OUTPUT signal will not be muted.
- The information after this operation is stored by the last memory function even after the power is switched OFF.

## OPERATION

### TIMER PLAY

This unit can perform timer play by cooperating with your audio timer.

Connect this unit's power cord to the audio timer's power socket and the timer's power cord to power outlet.

\* For connection to audio timer and its operation, please refer to the instruction manual of your audio timer.

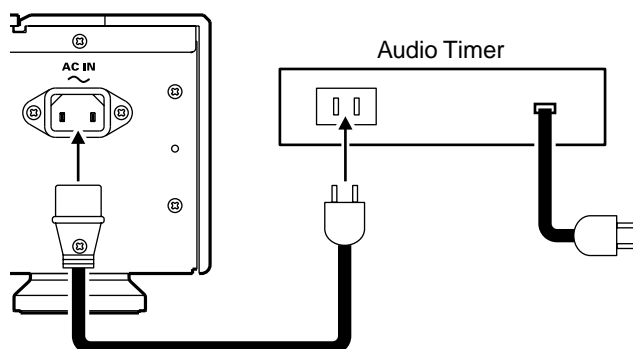

#### Setting method of Timer Play

- ① Press POWER switch to turn ON the power.
- ② Insert the disc to be played.  
\* In timer play mode, tracks are played normally.
- ③ Set the audio timer.

### ABOUT BALANCED JACKS

- ① The balanced output connector uses a XLR connector.
- ② The XLR connector for professional use is internally wired in either of the following two systems.
  1. USA system (Pin ② = COLD, Pin ③ = HOT)

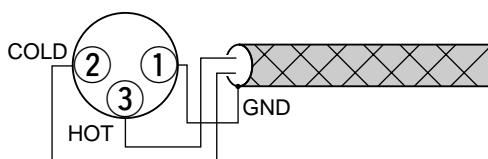

2. European system (Pin ② = HOT, Pin ③ = COLD)

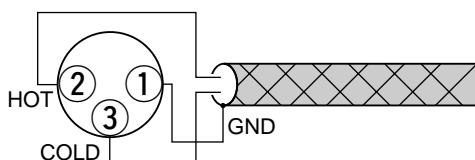

- ③ The SA-7S1 uses the 1. USA system.  
When a preamp or main amplifier adopting the European system is connected using a cable with XLR balanced connectors, the reproduced signal may be inverted of phase.  
In this case, refer to "ANALOG OUTPUT CONNECTOR PHASE SWITCHING", and set so that the correct phase is used.

### ANALOG OUTPUT CONNECTOR PHASE SWITCHING

By digitally processing audio signals read by this unit, it is possible to perform phase inversion without changing the tone quality.

Inverted signals are output from the UNBALANCED output connector, and the BALANCED output connector interchanges between HOT and COLD signals.

As the USA system has been adopted for the BALANCED output connector, if the amp or other device used with this unit is a European system device, a phase inversion cable would normally need to be used to playback with the correct phase. However, by pressing the INV. PHASE button on this unit, you can listen to the correct phase without replacing the cable.

Moreover, if a disc that has been recorded with the incorrect phase is being played, you can play it in the correct phase by pressing the INV. PHASE button.

#### To change the mode

Every time the INV. PHASE button on the front of this unit is pressed, the phase of the signal being output from the ANALOG OUTPUTS connector (BALANCED, UNBALANCED) is inverted. The indicator flashes during inverted playback.

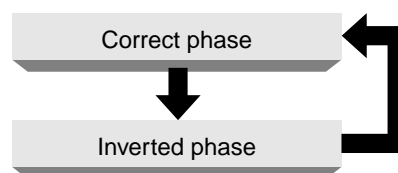

#### Caution

- Phase switching is only possible when the LCD display is turned on.
- If switching is performed during playback, sound output is stopped for approximately one second to prevent the occurrence of unnecessary noise.
- The information after this operation is stored by the last memory function even after the power is switched OFF.

# TROUBLE SHOOTING

If you think a malfunction has occurred, first check the points listed below. The problem is likely to have been caused by a simple operational error or a connection problem. If the problem cannot be corrected even after carrying out the following checks, consult your dealer or nearest Marantz sales office or service counter.

- **The disc fails to rotate.**

1. Is the mains lead plugged in properly?
2. Is the POWER switch ON?
3. Is the disc placed in the correct position on the disc tray?
4. Is the disc placed properly with the label side facing up?
5. Is the disc dirty?
6. Is the disc scratched?
7. Is the disc warped?
8. Is EXT. CLOCK (BNC terminal) connected? Also, is it set correctly?

- **The disc is rotating but no sound is heard.**

1. Are the amplifier and speakers connected properly?
  2. Is the amplifier switch ON?
  3. Is the amplifier's function or selector switch set to "CD" or "AUX" or such (to whatever you have connected this unit to)?
  4. Is the amplifier's volume control set at the minimum level?
- \* Occasionally, sound may stop if the equipment is installed near an air conditioning unit or refrigerator. If this problem occurs, either switch the main power off and on again, or press the OPEN/CLOSE button to open and close the tray, then try playing the disc again.

- **The disc stops in mid-operation.**

- **The sound drops out or noise is heard.**

1. Is the disc dirty?
  2. Is the disc scratched?
  3. Is the disc warped?
- \* In the case of a CD-R or CD-RW disc, this problem may occur when the conditions under which its data was originally written were substandard or when the quality of the disc itself is poor.
- \* This condition may occur in Mixed-Mode CDs, CD Extra, and other discs that have CDDA format mixed with other data. Noise may also be heard momentarily when skipping tracks.

- **Remote control operation is not possible.**

1. Is the transmitter of the remote control unit pointed correctly at the remote sensor on the front of the player (this unit)? Or is there an obstruction between the transmitter and the remote sensor?
2. Are the batteries in the remote control unit exhausted?
3. Is there another strong light (from a window, etc.) striking the Super Audio CD player's remote sensor?

- **A Super Audio CD cannot be played.**

1. Is the disc scratched, dirty or warped?
2. Is the amplifier's input selector set to digital? (Digital audio signal will not be output when a Super Audio CD is played.)
3. Is the disc a Super Audio CD multi-channel only disc? (This unit does not support Super Audio CD multi-channel.)

- **A CD-R/CD-RW disc cannot be played.**

1. Is the disc placed upside down?
2. Is the disc contains properly written TOC?
3. Is the recorded information in an audio (CD-DA) format?

- **A specific CD cannot be played**

Copy control CDs (CDs with copy guard) are special discs that do not comply with current CD standards. Marantz cannot guarantee the ability to play such discs on your CD player.

When normal CDs can be played without a problem and problems occur only when playing these special discs, it is not a problem with this unit.

Please ask the seller of the copy control CD for detailed information regarding copy control CDs.

- **The unit makes a clicking sound when the tray closes**

This is the adhesion click of the clasper for securing the disc. This does not cause any problem in using the unit.

- **While the disc is spinning, a spinning sound is heard or a slight vibration occur.**

Depending on the disc, a spinning sound may occur or the unit may vibrate slightly due to disc eccentricity or such. This is not a problem with this unit.

# SPECIFICATIONS

	Super Audio CD	Audio CD
Audio Characteristics		
Analog output		
Channels	2channels	2channels
Frequency range	2Hz — 100kHz	2Hz — 20kHz
Frequency characteristics	2Hz — 50kHz (-3dB)	2Hz — 20kHz
Dynamic range	114dB (Filter 3)	100dB (Filter 1)
THD (1kHz)	0.0009% (Filter 3)	0.0020% (Filter 1)
wow & flutter	Precision of quartz	Precision of quartz
Output level		
Unbalanced	2.5V RMS stereo (Filter 3)	2.3V RMS stereo (Filter 1)
Balanced	5V RMS stereo (Filter 3)	4.6V RMS stereo (Filter 1)
Digital output		
output level (cinch JACK)	—	0.5Vp-p (75Ω)
output level (optical)	—	-19dBm
Ext. Clock input		
Clock frequency	44.1kHz, 88.2kHz, 176.4kHz	
Input level (BNC terminal)	1V—5Vp-p (75Ω)	
Optical Readout System		
Laser	AlGaAs	AlGaAs
Wave length	650nm	780nm
Signal format	1-bit DSD	16-bit linear PCM
Sampling frequency	2.8224MHz	44.1kHz

### Power Supply

Power requirements (U.S.A.) ..... AC 120V 60Hz  
 Power requirements (China) ..... AC 220V 50/60Hz  
 Power Consumption ..... 26W

### Cabinet, etc.

Dimensions (Width × Height × Depth) ..... 18 1/8 × 5 3/8 × 16 13/16 inch (459 × 136 × 425.5mm)  
 Net weight ..... 22.3kg  
 Operating temperatures ..... +5°C ~ +35°C  
 Operating humidity ..... 5 ~ 90% (without dew)

### Accessories

- Remote control ..... 1
- Dimensions (Width × Height × Depth) ..... 1 15/16 × 13/16 × 9 inch (48.5 × 20 × 227.5mm)
- Net weight ..... 160g
- AAA (R03) Batteries ..... 2
- AC Power cord ..... 1
- Audio cable ..... 1
- User's Guide ..... 1
- Warranty Card (USA) ..... 1
- Warranty Card (CANADA) ..... 1

Specifications subject to change without prior notice.

### ■ Dimensions (unit: inch (mm))

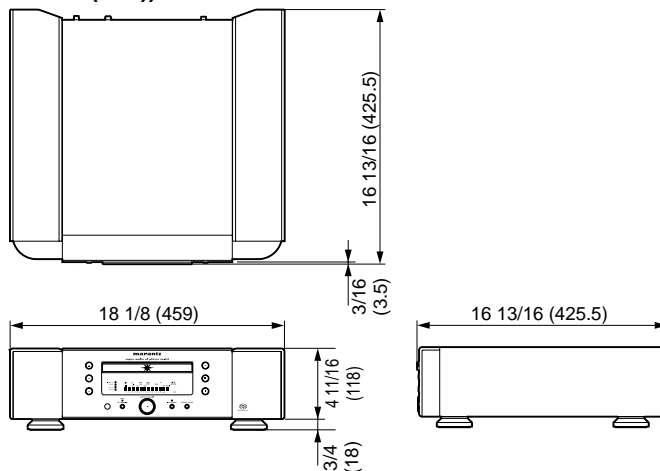

**[www.marantz.com](http://www.marantz.com)**

You can find your nearest authorized distributor or dealer on our website.

**marantz**<sup>®</sup> is a registered trademark.

